

Varenummer: 438000090

Beskrivelse: Rota-fix spændelement SD 90

## Mål

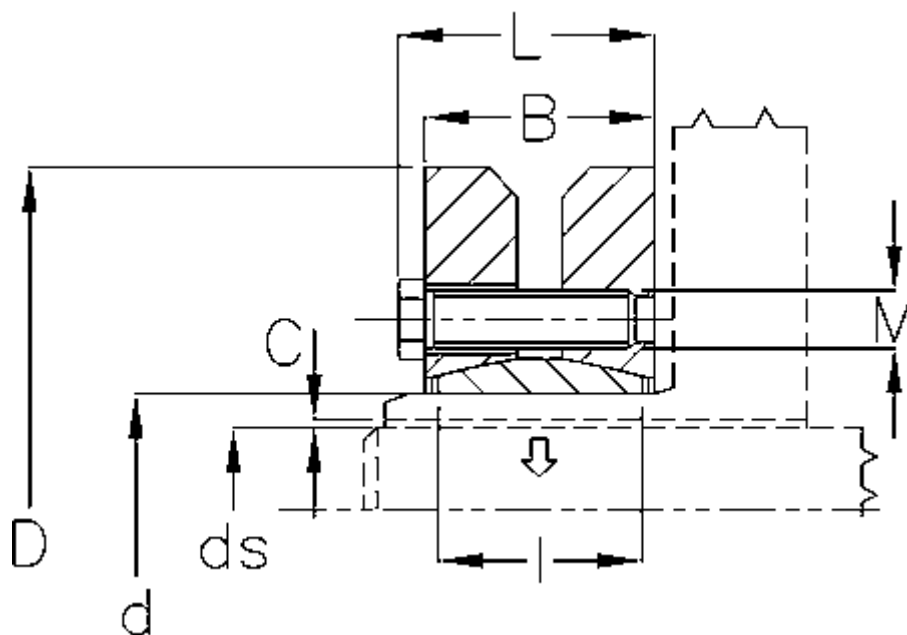

B mm	= 39
C maks.	= 0,069
d H8 mm	= 90
D mm	= 155
ds mm	= 65
F kN aksialkraft	= 170
L mm	= 45
l mm	= 30

M mm	= M8
T Nm drejningsmoment	= 4700
Ts Nm boltetilspændingsmoment	= 30